



January 2024-2025

Guidelines for Bits in Pennsylvania 4-H Horse Shows

These guidelines should be used in conjunction with the current *Pennsylvania 4-H Horse Show Rulebook* and any available supplement. See rulebook for additional details involving bits and equipment for respective divisions and classes.

Because the Pennsylvania 4-H Horse Program is diverse in both its divisions and in the breeds that compete, it is difficult to generate a complete list of acceptable bits. Bits that are permitted by respective breed associations may be acceptable at the judge's discretion. A judge at his/her discretion can penalize a horse with non-conventional types of bits, nose bands or other equipment.

If exhibitors have questions concerning a bit they wish to use, and that specific bit is not mentioned in the current rules or these guidelines, then exhibitors should ask the show stewards and/or the judge if the bit is acceptable for that show. Exhibitors should have alternative bits available so that they can make a change if it is determined by show officials that their preferred bit is unacceptable for that show.

Each county, district or regional, and state show is officiated by different stewards and judges. Therefore, exhibitors must seek approval from show officials at each show before using the questionable bit.

Members should consult with professionals in their riding discipline or contact the appropriate breed association for guidance in selecting a bit in order to find one that is both appropriate and acceptable for use in Pennsylvania 4-H shows.

No horse or pony may be shown with their tongues tied down or with their mouths tied shut. The correct use of a cavesson does not constitute tying a mouth shut.

Western Bits

References to a bit in Western Division classes include either a curb bit or a snaffle bit. Horses five years old and younger may be shown with a shanked (curb) bit, hackamore or a snaffle bit. If a hackamore or snaffle bit is used, the horse may be ridden with one or two hands. Horses six years old and older must be shown with a shanked bit, and only one hand is to be used for reining regardless of type of bit used and hands shall not be changed, except where permitted in Trail and Novice Reining.

A *curb* bit has a solid or broken mouthpiece, has shanks and acts with leverage. All curb bits must be free of mechanical device. Shanks may be fixed or loose, and the maximum length should not exceed 8 ½ inches. The mouthpiece must be round, oval or egg shaped, smooth and unwrapped metal, 5/16" to ¾" in diameter, when measured 1" from the cheek piece or shank. Nothing may protrude below the mouthpiece, such as extensions or prongs (including upward prongs) on solid mouthpieces. The mouthpiece may be two or three pieces, which lie flat in the horse's mouth. The port must not exceed 3 ½" in height, with rollers and covers being acceptable. Broken mouthpieces, half-breeds and spades are permitted. Slip or gag bits, and donut and flat polo mouthpieces are not acceptable.

Western Bits (continued)

When a curb bit is used in Western classes, a curb strap or curb chain is required (*includes Tom Thumb bits*). The curb strap or chain must be at least one half inch in width, lie flat against the horse's jaw, and meet the approval of the judge. A broken strap or chain is not necessarily cause for disqualification. Any bit having a fixed rein that functions with leverage or has a port should be used with a curb chain or strap (i.e. Myler or similar type bits).

Snaffle bits in Western classes mean the conventional O-ring, egg-butt or D-ring with a ring no larger than 4". The inside circumference of the ring must be free of rein, curb or headstall attachments, which would provide leverage. The mouthpiece should be round, oval or egg-shaped, smooth and unwrapped metal. It may be inlaid, but must be smooth or latex-wrapped. The mouthpiece must be a minimum of 5/16" in diameter when measured 1" from the cheekpiece, with a gradual decrease to the center of the snaffle. The mouthpiece may be two or three pieces, which lie flat in the horse's mouth. An optional loose chin strap may be used (leather or nylon only). Reins to be attached above the chin strap.

The Western horse, provided it is considered a junior horse (5 yrs. and under) may also be ridden with a hackamore. The hackamore must be of a flexible, braided rawhide or leather, or rope bosal, the core of which may be either rawhide or flexible cable. Absolutely no rigid material will be permitted under the jaws, regardless of how padded or covered. A hackamore should be used with a complete mecate rein, which includes a tie rein. The so-called mechanical hackamores are not permitted in any classes except the Contest classes.

Bits for Contest Division

There are a tremendous number of different bits and mechanical hackamores that are traditionally used in Contest classes. There are very few prohibited bits and hackamores *other than those* that the show committee, stewards and/or the judge deem to be cruel and inhumane. The exhibitor should be prepared with alternative headgear for their animal if they are found to be using an inappropriate bit or hackamore.

Hunt Seat Bits

An English snaffle (no shank), kimberwick, Pelham and/or full bridle (with two reins), all with cavesson nosebands and plain leather brow bands must be used. Nothing may protrude below the mouthpiece. Solid and broken mouthpieces may have a port no higher than 1 1/2". On broken mouthpieces only, connecting rings of 1 1/4" or less in diameter or connecting flat bar which lies flat in the horse's mouth are acceptable. All mouthpieces must be a minimum of 5/16" in diameter when measured 1" from the cheek or ring. The snaffle bit ring may not exceed 4" in diameter. Any bit having a fixed rein that functions with leverage or has a port should be used with a curb chain or strap (i.e. Myler or similar type bits). When a curb strap or chain is used, it must be at least 1/2" in width, lie flat against the horse's jaw, and permit the entry of two fingers between the horse's jaw and the curb strap or chain. Smooth round, oval or egg-shaped, slow twist, corkscrew, single twisted wire or double twisted wire mouthpieces and straight bar or solid mouthpieces are allowed.

Bits of any style (Pelham, snaffle, kimberwick) featuring mouthpieces with cathedrals, donuts, prongs sharp edges or rough, sharp material shall be cause for elimination. Slip or gag bits or hackamores of any type are not permitted.

Saddle Seat Bits

The type of bits used in the Saddle Seat Division will vary with the breeds that may be seen in the 4-H program. However, all animals should be shown with either a Pelham, single curb, or a Full Bridle (double bridle). Bits that are permitted by respective breed associations may be acceptable at the judge's discretion. A judge at his/her discretion can penalize a horse with non-conventional types of bits or nose bands.

A pelham is a compromise between a snaffle and a double bridle. It is a good bit to start a less accomplished rider towards the use of two reins. The use of a bit converter (a U-shaped piece of leather that fastens between the snaffle ring and the curb ring at the end of the shank on the pelham) is not illegal, however, it is not considered correct amongst most judges, and therefore may be penalized. The mouthpiece of a pelham may be jointed, straight, or ported.

A single curb is permitted with many breeds ridden Saddle Seat that do not have a natural trot, such as Walking Horses and other "easy gaited" breeds. Any single curb should always be worn with a curb chain or strap.

A full or double bridle utilizes two bits (snaffle and curb) in the horse's mouth simultaneously. Either of the two bits should have a jointed (broken) mouthpiece and the other should have a straight (unbroken) mouthpiece. A bridoon, is the small snaffle fitted in the mouth above the curb or Weymouth bit and should generally be 1/4 inch longer than the Weymouth. It is usually quite thin, and may be an egg-butt or loose-ring type. The Weymouth or curb bit is fitted below the bridoon. The Weymouth should always be worn with a curb chain or strap and a lip strap, which encourages the curb chain to remain in place. When a curb strap or chain is used, it must be at least 1/2" in width, lie flat against the horse's jaw, and permit the entry of two fingers between the horse's jaw and the curb strap or chain. The mouthpiece of the Weymouth may be a straight bar or ported.

A gag bit with no shanks is not considered a standard Walking Horse bit and should not be used. Gag bits with shanks may be permitted if acceptable by respective breed associations and at the judge's discretion.

Driving Bits

Animals used in driving may be fitted with a snaffle of the half-cheek variety, with the mouthpiece being either jointed or a straight bar, or a Wilson snaffle which has two extra floating rings to which the cheekpieces of the bridle are attached. When a Wilson snaffle is used, the reins should be buckled through both rings. The Wilson snaffle can have flat or wire cheeks.

Other traditional carriage bits that are curb bits may be used, such as the Liverpool, Buxton (only with draft horses), elbow, butterfly or post bit. These bits must be used with a curb chain or strap. These bits may have a variety of mouthpieces, jointed, straight, or ported. Rein attachment to these bits vary as to the degree of control needed by a particular horse or in a particular situation. Reins may be attached to the plain cheek (the ring at the mouthpiece), or in the variety of rein slots on the shank of the bit. It is recommended that reins are not attached to the bottom slot.

No type of "bitless" bridle may be used in driving classes.

Dressage Bits

Classical Dressage – Animals to be shown in a plain snaffle bridle and regular cavesson. A dropped noseband, a flash noseband, or a figure 8 noseband are also acceptable. Nosebands may not contain metal other than the buckles. Micklem bridles are acceptable. All bits must be smooth.

Western Dressage – Animals to be shown in a western bridle. The use of a western cavesson (flat, rolled, braided, or plain, with an adjustable noseband), or pencil bosal with or without a get-down rope with space for two fingers placed between the cavesson and the jowl of the horse is optional. No metal (except for the buckle on the cavesson), studs of any kind, or other substances can be used in conjunction with or as part of a Western cavesson.

A snaffle bit may be used on a horse of any age, ridden at any level. All bits must be smooth. Twisted, wire, and roller bits are prohibited.

Any standard western curb bit may be used on a horse of any age, ridden at any level. Reins must be attached to each shank. If riding with a curb bit, you may use one or two hands on the reins. Use of a romal is also acceptable. If a romal is used, hobbles and a rope are optional and must be attached to the saddle.

Detailed information on western snaffle and curb bits may be found in the Western Bits section of this document.

A hackamore (bosal) is permitted on a horse of any age, and at any level. The hackamore must be of a flexible, braided rawhide or leather, or rope bosal, the core of which may be either rawhide or flexible cable. Absolutely no rigid material will be permitted under the jaws, regardless of how padded or covered. A hackamore should be used with a complete mecate rein, which includes a tie rein. If riding with a hackamore (bosal) you must use two hands on the reins.

Refer to the Dressage Guidelines available from county extension offices or on the Pennsylvania 4-H Horse Program SharePoint website for additional information.

**B
I
T

M
E
A
S
U
R
E
M
E
N
T
S**

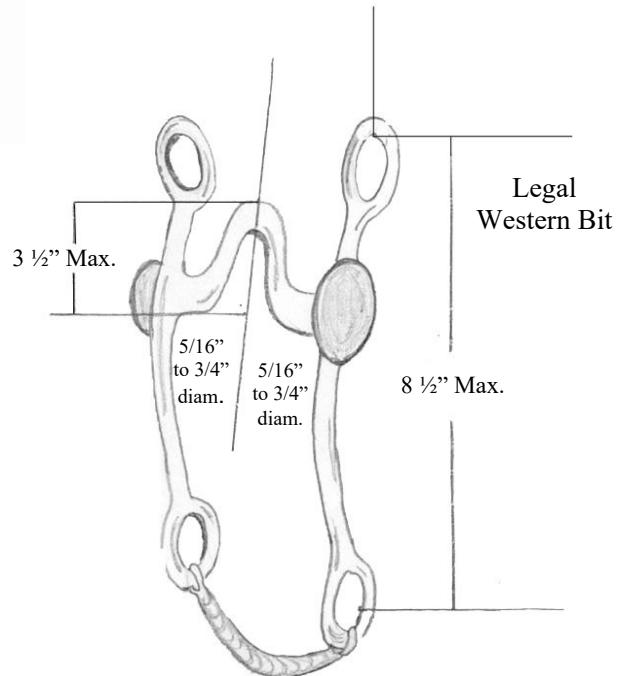
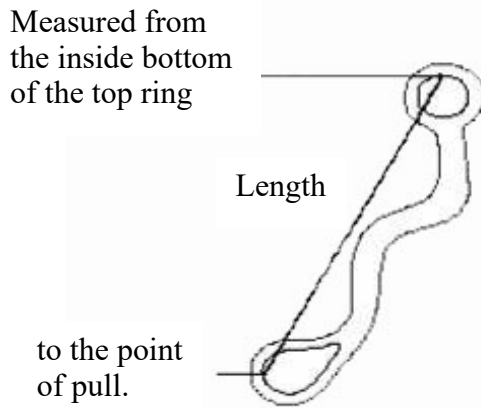
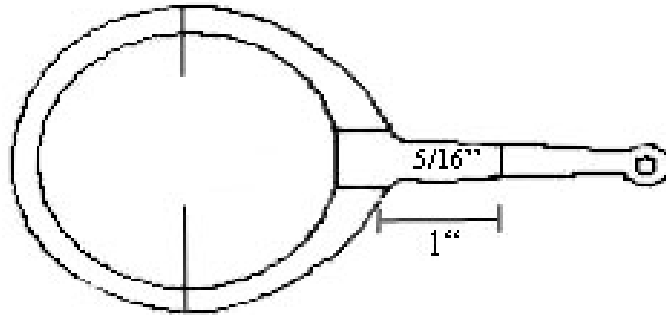
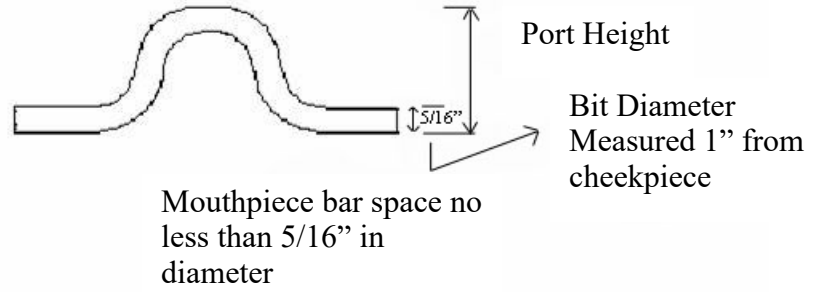

WESTERN
BITS



HACKAMORE
(Non-mechanical
or bosal)



CURB BIT



D-RING SNAFFLE



EGG-BUTT SNAFFLE



TOM THUMB
Classified as a curb
or leverage bit



O-RING SNAFFLE

H
U
N
T
S
E
A
T
B
I
T
S

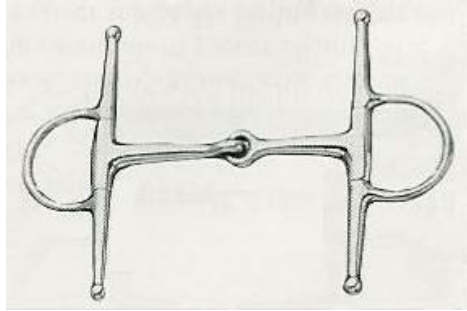

FULL CHEEK



D-RING SNAFFLE

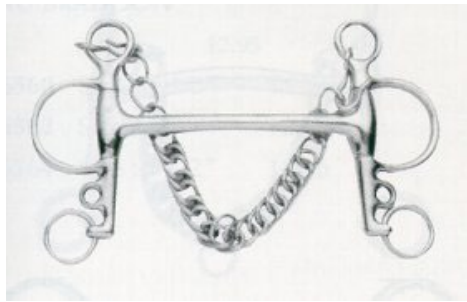

PELHAM



EGG-BUTT SNAFFLE



KIMBERWICKE



O-RING SNAFFLE

S
A
D
D
L
E
S
E
A
T
B
I
T
S



**SINGLE CURB
BRIDLE**



**WEYMOUTH OR
FULL BRIDLE**

**D
R
I
V
I
N
G
B
I
T
S**

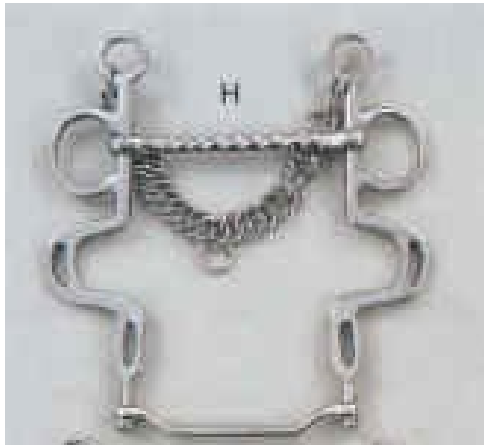

BUXTON



BUTTERFLY



ELBOW



LIVERPOOL

**G
A
G
B
I
T
S**



**With Shanks
Only permissible in
contest classes and saddle
seat division as noted.**



**Without Shanks
Permissible in contest
classes only.**